

LED Auxiliary Light for Can-Am Ryker

ZP-YJ-030602-014



BEFORE YOU BEGIN

Read these instructions and check to be sure all parts and tools are accounted for. Please retain these installation instructions for future reference.

IMPORTANT

Your ON ROAD KIT is exclusively designed for your vehicle. Please read the installation instructions thoroughly before beginning. Installation is easier if the vehicle is clean and free of debris.

Note: Shift vehicle transmission into "PARK". Turn key to "OFF" position and remove from vehicle.

3. Remove the glove box cover and pull the fuel filler door.

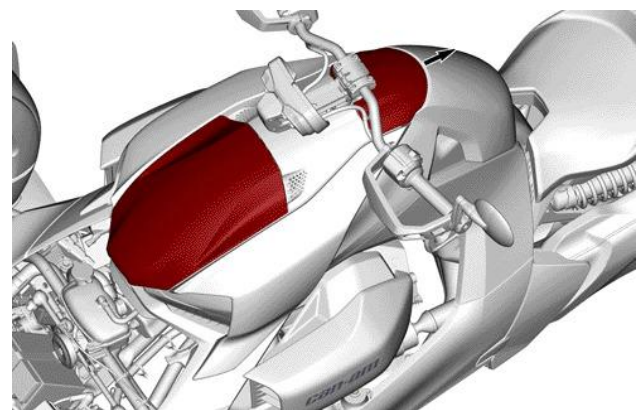
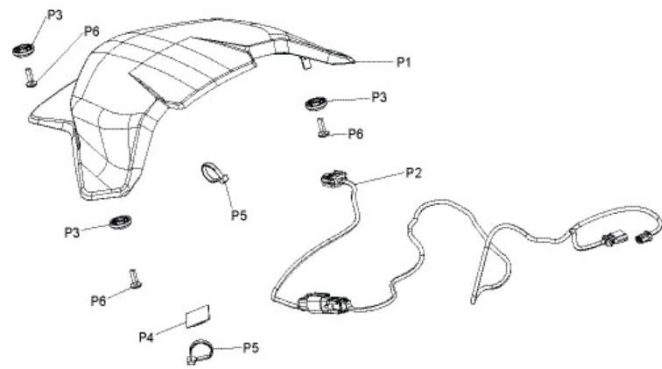

INSTRUCTIONS

Part Installation

1. Remove the front service cover.

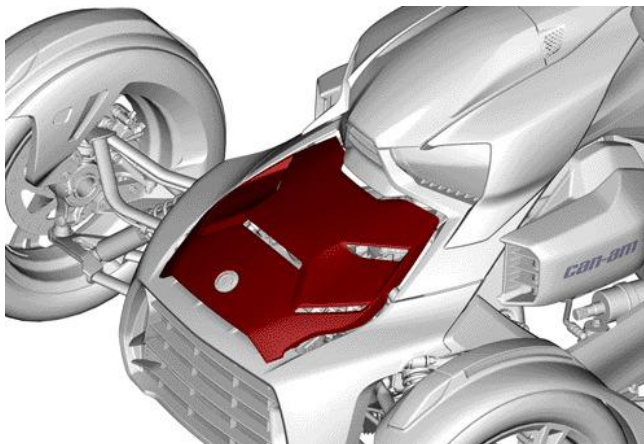

2. For Ryker 900 Rally Edition model, remove the front service cover trim.



4. Remove the plastic rivets.

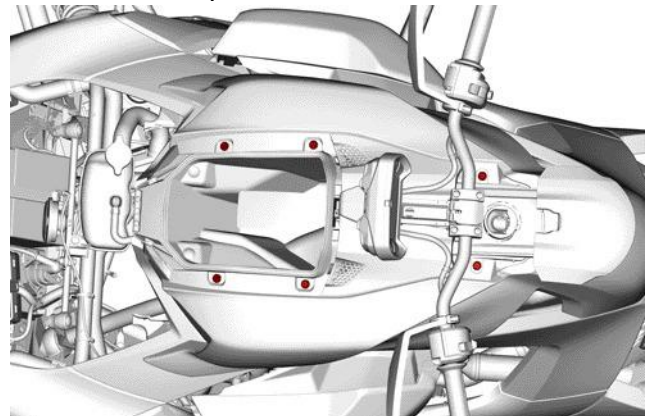

5. Remove the left side and right side fairings.

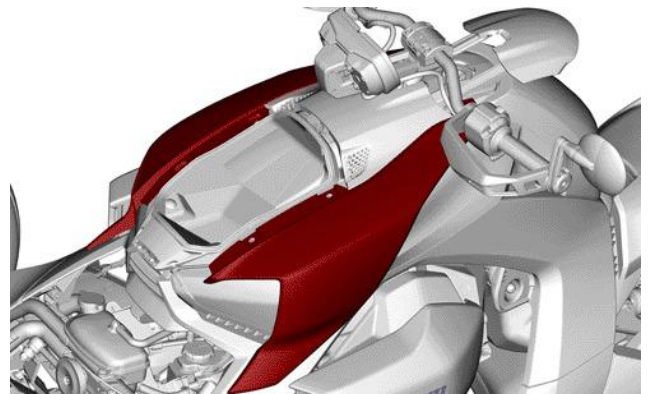

6. Remove the bottom of the glove box.

LED Auxiliary Light for Can-Am Ryker

ZP-YJ-030602-014

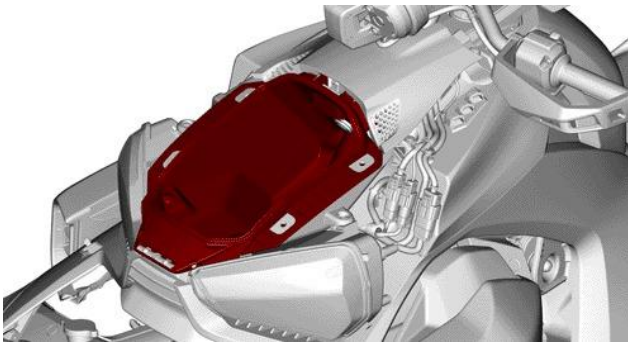

7. Drill the front service cover at four pre-marked locations with 10 mm (3/8 in) drill bit.



8. Route the cable of the assembled auxiliary LED light [P1] in the center hole.

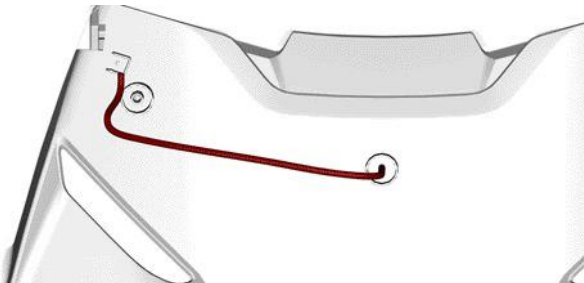

9. Connect the connector to the cable.

NOTE: Black wire in position 1 and red wire in position 2.

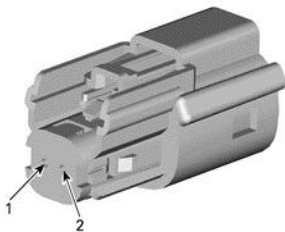

- 1. Position 1
- 2. Position 2

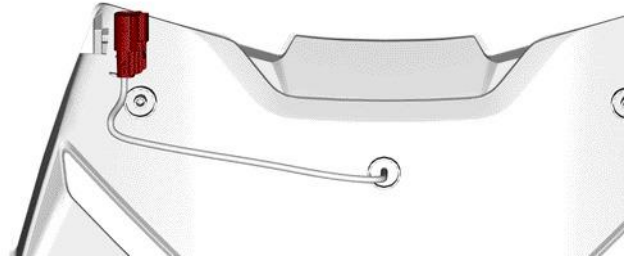

10. Fix the assembled auxiliary LED light [P1] with three anchor washers [P3] and three K50x16 torx screws [P6]. Tighten to specification.

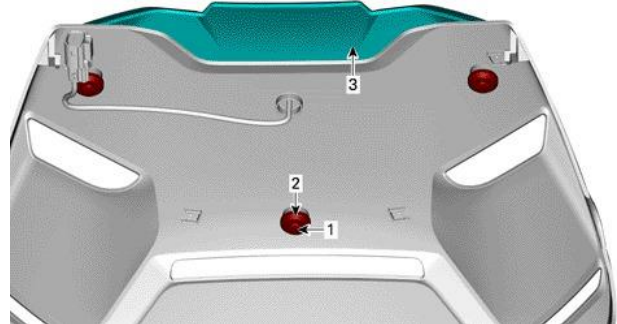

- 1. K50x16 Torx screw [P6]
- 2. Anchor washer [P3]
- 3. Assembled auxiliary LED light [P1]

Tightening torque

K50x16 Torx screw [P6] $1 \pm 0.2 \text{ N}\cdot\text{m}$ ($9 \pm 2 \text{ lbf}\cdot\text{in}$)

11. Secure the cable with the locking tie mount [P4] and a locking tie [P5].

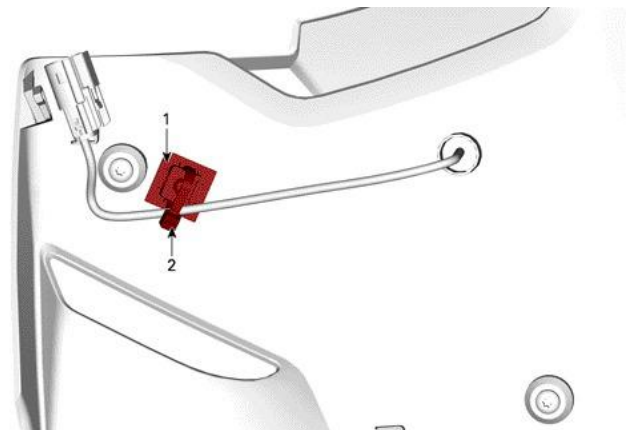

- 1. Locking tie mount [P4]
- 2. Locking tie [P5]

12. Route the harness by following the vehicle harness.

NOTE: It's recommended to insert the wiring into the rib holding the vehicle harness.

LED Auxiliary Light for Can-Am Ryker

ZP-YJ-030602-014

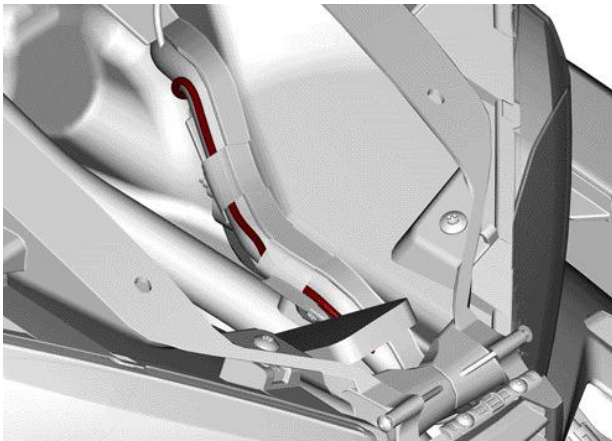

13. Disconnect the vehicle connector of the accessory housing.

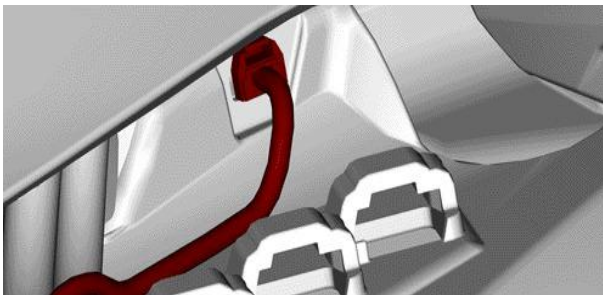

14. Place the female connector into the housing on the body, connect the male connector to the accessory housing and connect the vehicle connector into the female connector.

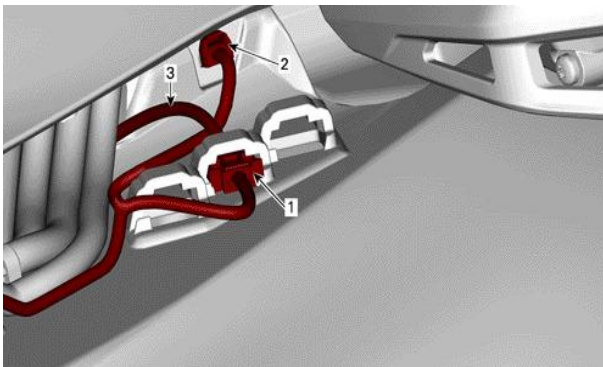

1. Place the female connector into the housing
2. Connect the male connector into the accessory housing
3. Connect the vehicle connector into the female connector

15. Locate the connect support near the front service cover anchor.

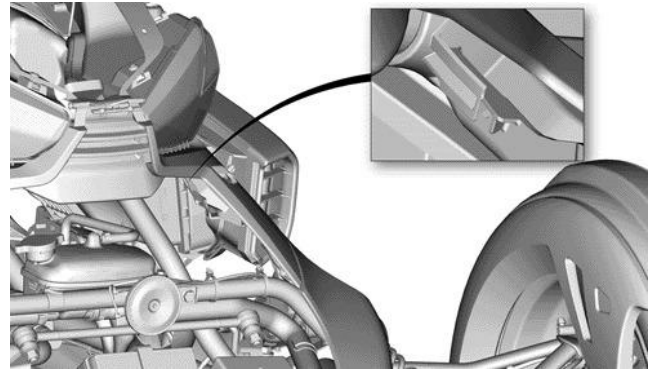

16. Slide the connector on the support.

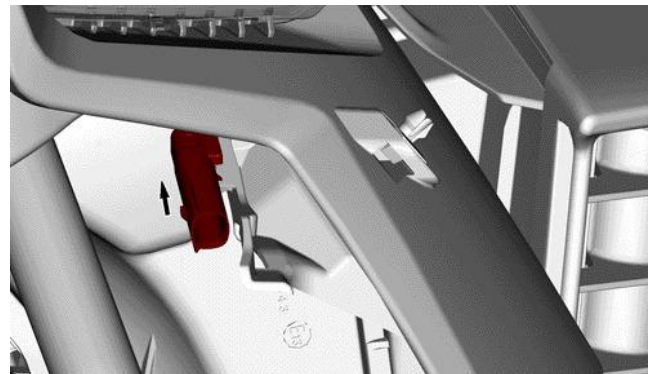

17. Connect the auxiliary light and reinstall front service cover.

18. Reinstall previously removed body parts. However pay attention to the following.

NOTE: On Ryker 900 Rally Edition models, the front service cover trim is not compatible with the auxiliary light kit.

